

SPECIFICATION

R1-240Y-260ZQ Series Waterproof Power Supply

Product Name: R1-T240Y-260ZQ

Summarize: 240W LED Driver

Version: V00

Release date: 2022-08-20

Customer ID: _____

Customer Model: _____

Products Code: _____

Sample Model: _____

Version: _____

SIGNATURE AND SEAL BY US		
Date:	2022/08/20	
Prepared By	Checked By	Approved By
Dingquan Lu	Zhuanhong Wu	Tom Wu

Features:

Please confirm and send it back with signature within 7 days. Otherwise we will assume your acceptance. And if any quality dissent, there will be an executor according to this product specification.		
CUSTOMER APPROVED SIGNATURE		
Customer Model No:		
Date:		
ENG	QA	OTHER

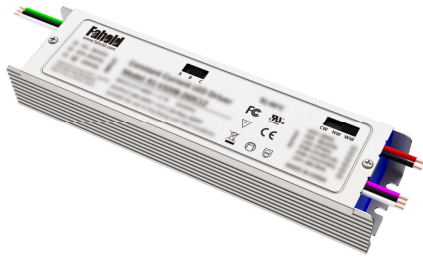

- ◆ IP44 protection grade;
- ◆ Constant current design,
- ◆ Various dimming methods: 0(1)-10V dimming, PWM, RX,
- ◆ Smooth dimming from 5% to 100%, compatible with three levels of color temperature, three levels of power adjustment;
- ◆ Surge protection: DM: 6KV, CM: 6KV;
- ◆ Protections: SCP/OVP/OTP
- ◆ Optional 12V/200mA auxiliary;
- ◆ The dimming signal is isolated from the LED output;
- ◆ 5 years warranty

Application:

Street lights, Industrial lights, Grow lights, Landscape lighting

Introduction

This document details the electrical performance and environmental requirements of 240W LED constant current driver with 0(1)-10V dimming. This power supply is only suitable for LED loads.

Model and Key parameters Table 1

Model	Max. output Power	Nominal input voltage	Input Voltage Range	Output Voltage Range	Max output Voltage	Max. Output current	Full-power Current range	Default output current	Efficiency @120V	Efficiency @277V
R1-240Y-260ZQ	240W	120-277	108-305	180-260	310V	1.2A	075-1.1A	1A	92%	94%

Mode code naming rules

R1 - 240 Y-260 Z Q

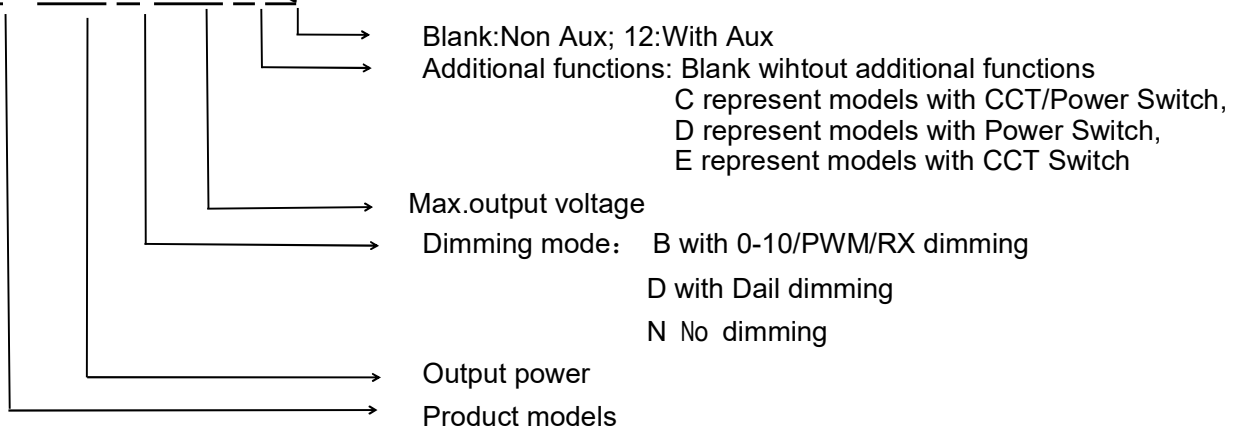

Technical Data

Input characteristics	
Input voltage	120-277Vac
Input Frequency	50/60Hz
Input Current (Typ.)	2.5 A @ 120Vac , 100% load
Standby power consumption	2.5W MAX
Inrush current	75A max. @ 120Vac, 25°C cold start
Power factor (Typ.)	PF>0.90 @ 120-277Vac ,100% load
THD	THD<20% @ 120-277Vac,100% load
Output characteristics	
Current accuracy	± 5%
Efficiency	≥92% @120Vac, ≥95% @277Vac
Output Voltage	180-260V
Ripple current	<5%
Linear adjustment rate	3%
Load Regulation	3%
Boot delay	Max 1.0 seconds@230VAC
Programmable current output range	Nominal voltage and current range can be adjusted by controller programming; The total output power does not exceed 240W (actual output voltage x actual output current = power).
Protective function	
Open circuit protection	When the LED is open, the product enters the protection state, such as hiccup or clamping at the highest output voltage state, the product will not be damaged, and the power supply will resume normal operation when the fault is eliminated or restarted.
Short circuit protection	When the output is short-circuited, the input power will be reduced accordingly. After the short-circuit condition is removed, the power supply will automatically return to normal.
Over temperature protection	Drop current mode. When the over temperature is removed, the current will automatically resume.
Environmental conditions	
Operating temperature	-40°C - +50°C
Humidity	10% - 90% RH, (not condensed)
Storage temperature	-40°C to +75°C
Storage humidity	10% - 90%RH, Non-condensing (sea level to 2000 meters)
vibration	10 - 500HZ X, Y, Z vertical axes vibrate at a constant acceleration of 1.0G (depth 3.5mm) for 1 hour
Protection class	IP44
Safety standard	
Dielectric strength	Primary--Dim: 1560VAC/10mA/3S Primary--ground: 1560Vac/10mA/3S
Insulation resistance	I/P-O/P: >10MΩ@500VDC (Control terminal)

Leakage current	At the maximum input voltage, the leakage current of the product should be less than 0.75mA
Safety standards	UL:UL8750
Electromagnetic interference	FCC: PART 15B Subpart B; ANSI C63.4:2014
ESD Electrostatic Discharge (Electrostatic) Immunity	Electrostatic discharge/immunity level 3 air discharge: $\pm 8\text{KV}$ Level 2 Contact discharge: $\pm 4\text{KV}$ Performance standard: B
RF field strength	Radio frequency electromagnetic field drug susceptibility test, 80-1000MHZ; level 2, 3V/M; Performance standard: A
Group pulse	1.0KV (performance standard: B)
Surge lightning strike	Differential mode: 6kV Common mode :6KV Performance Standard: C
Reliability	
Lifespan	≥ 5 years @230Vac, 100% load. See Life Cycle and Tc Curves for details
Mean time between failures	$\geq 200,000\text{H}$ @ 25 °C, 230Vac, 80% load. (MIL-HDBK-217F)
Warranty	5 years (at 80% continuous load)
Other	
Size	189*51*35mm
Weight	505g+/-10g
Remark	
<p>1. It is recommended that customers install over-voltage protection and surge protection devices in the power supply circuit of lamps to ensure the safety of electricity use.</p> <p>2. The power supply is used as a component of the whole lamp in combination with the terminal equipment. Because the EMC performance is affected by the LED lamps and wiring, the terminal equipment manufacturing The manufacturer needs to re-confirm the EMC of the whole device.</p> <p>3. Please use a special programmer to adjust the current of the power supply, and program and write through the dimming light.</p> <p>4. When adjusting the output current of the power supply, please ensure that the total output power does not exceed the rated maximum power.</p> <p>5. Unless otherwise specified, the above parameters are the test results under the conditions of ambient temperature 25°C, humidity 50%, 100% load, and input voltage 277Vac.</p>	

Dial the code function

Type	Gears	Min	Iout	Max	Remarks
power regulator	A	$0.95 \cdot I_o$	I_o	$1.05 \cdot I_o$	I _o is rated output current value, rated value set in A position
	B	$0.70 \cdot I_o$	$0.75 \cdot I_o$	$0.80 \cdot I_o$	
	C	$0.45 \cdot I_o$	$0.50 \cdot I_o$	$0.55 \cdot I_o$	

Temperature	CW	Cold light	6000K	Red LED+/Black LED-	Common male connection, rated CW
	NW	white light	4500K	Red LED+/Black/Pink LED-	
	WW	Warm light	3000K	Red LED+/PinkLED-	

■ Dimming function

Dimming type	parameter	minimum	Typical value	maximum	Remark
0-10V 1-10V	signal level	0V		10V	
	Dimming range	10%		100%	Output current percentage
	shutdown level	0.6V	0.7V	0.8V	
	turn on level	0.75V	0.85V	0.95V	
PWM	signal level	0V		10V	
	signal frequency	200Hz	1KHz	2KHz	
	duty cycle	5%		100%	
Resistor	resistance	10kΩ		100kΩ	
	Dimming range	10%		100%	Output current percentage

■ Dimming range

Function			0-10V				PWM			RX		
Yes Or No			Y				Y			Y		
0-10V	0	1	2	3	4	5	6	7	8	9	10	open
Ir	0	10%	20%	30%	40%	50%	60%	70%	80%	90%	100%	100%
PWM	0%	10%	20%	30%	40%	50%	60%	70%	80%	90%	100%	open
Ir	0	10%	20%	30%	40%	50%	60%	70%	80%	90%	100%	100%
RX	0Ω	10KΩ	20KΩ	30KΩ	40KΩ	50KΩ	60KΩ	70KΩ	80KΩ	90KΩ	100KΩ	open
Ir	0	10%	20%	30%	40%	50%	60%	70%	80%	90%	100%	100%

Remark:

1. the percentage of output current
2. typical values

Efficiency VS. Load

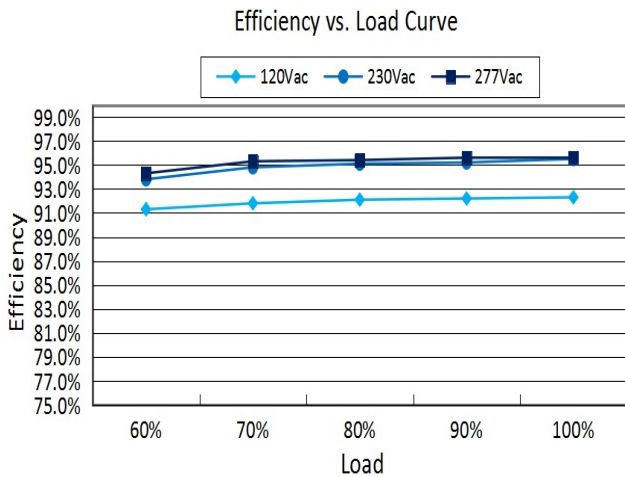

Power Factor

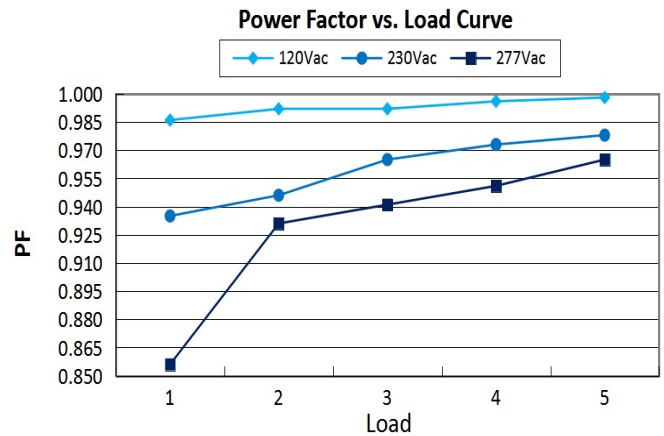

THD VS. load

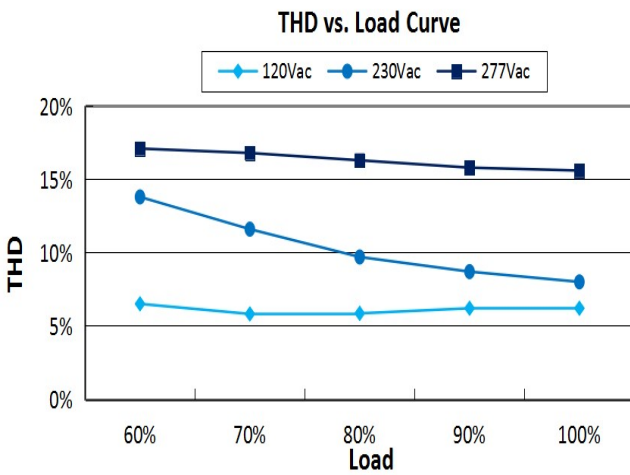

life and temperature

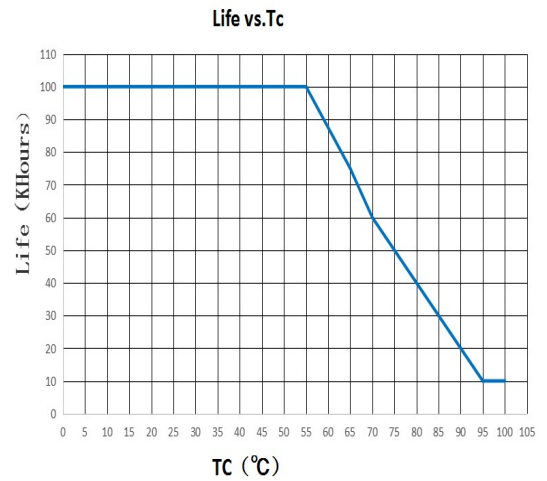

Power curve

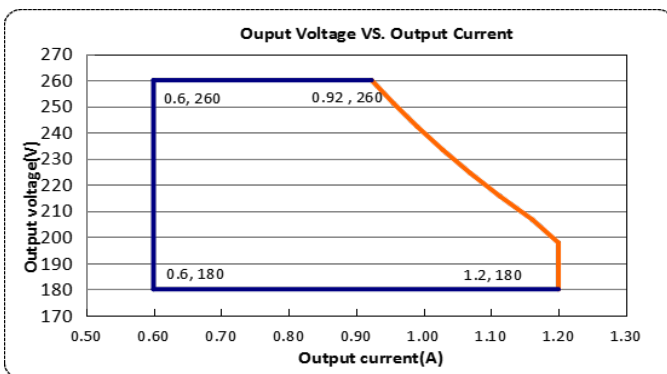

Dimming curve

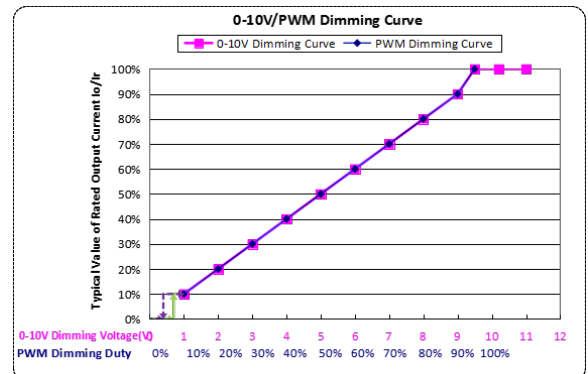

Remark:

- 1: Load 1 --- 60% Load
- 2: Load 2 --- 70% Load
- 3: Load 3 --- 80% Load
- 4: Load 4 --- 90% Load
- 5: Load 5 --- 100% Load

Output power Vs. Input voltage

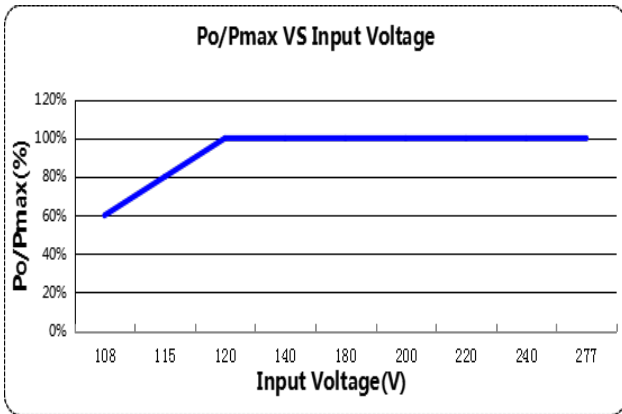

Output power vs. Ta

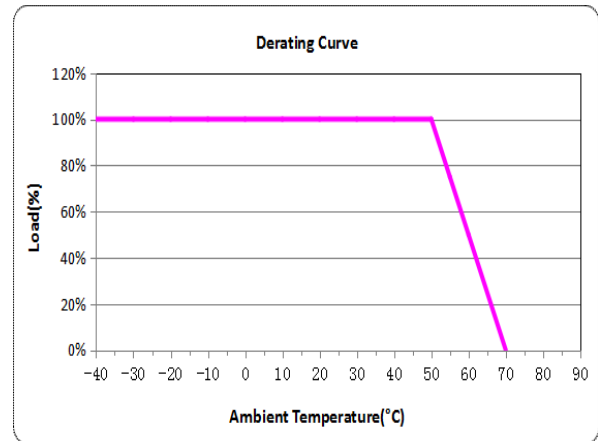

Schematic diagram of appearance size

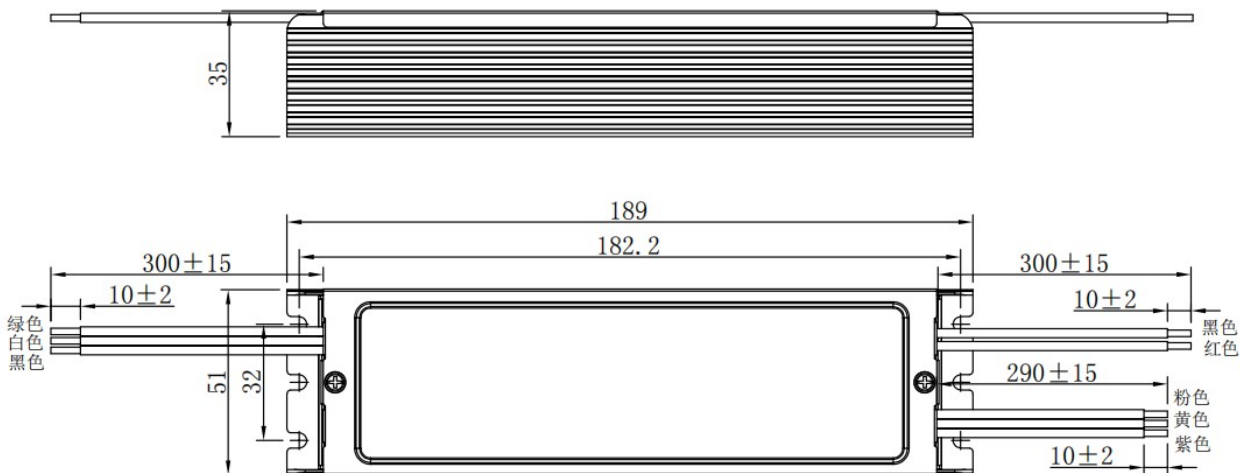

Input Wire	UL1015	18AWG 600V, Black: L, White: N, Green: PE
Output Wire	UL1015	18AWG 300V, Red: LED+, Black: LED-
Dimming Wire	UL1015	22AWG 300V, Purple: DIM+, Pink: DIM-/12V yellow: 12V+

Installation considerations

1. The lightning protection level of the power supply meets the standard requirements of IEC61000-4-5 and other countries. If it is used in lightning-prone areas or areas with relatively complex power grid environment, it is recommended to install a professional lightning protection module on the AC input end of the power supply.

Packaging, Transportation & Storage

1. Packaging

Option 1

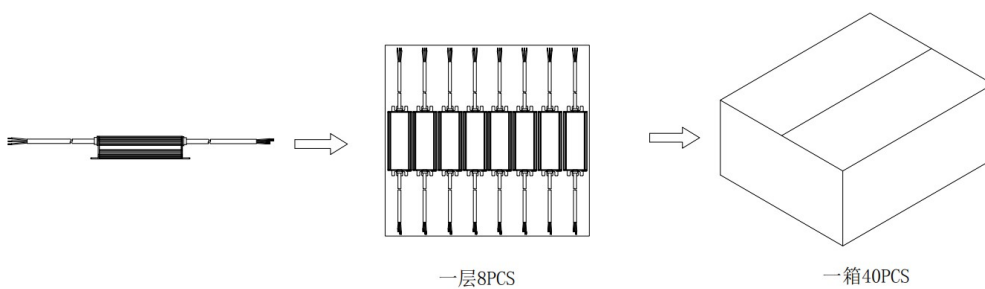

Box size	425mmx310mmx225mm (L×W×H)
quantity	8PCS/Tier; 5Tier/Box; 40PCS/Box
weight	505g±5g/PCS; 20Kg±50%/Box

Option 2

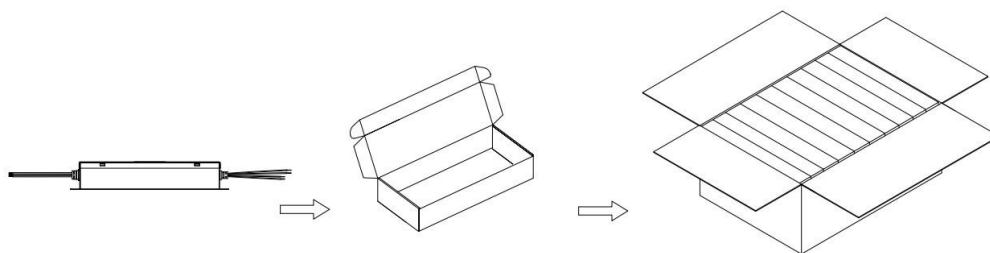

Box size	425mmx310mmx225mm (L×W×H)
quantity	8PCS/Tier; 2Tier/Box; 16PCS/Box
weight	505g±5g/PCS; 9Kg±50%/Box

2. Shipping

It is suitable for transportation by car, ship and plane. It should be covered with awning, sun protection and civilized loading and unloading during transportation.

3. Storage

Product storage should comply with the provisions of GB3873-83.

Products with a storage period of more than one year should be re-inspected and can only be used after passing the test.

Disclaimer:

The content of this manual is made based on the existing information of the product. Due to product version upgrade or other reasons, its content may be changed. The company reserves the right to improve the product without prior notice, and reserves the right of final interpretation for the performance description of the company's products. , The company is committed to improving the quality of products, and constantly upgrade and optimize products.

Product installation and use precautions

- Do not connect the AC power supply to the DC output port and dimming port.
- Do not use more than the nominal power of the power supply.
- Do not use the power supplies in parallel on the same lamp.
- This product is a constant current LED power supply, only suitable for LED lamps.

Safety and Precautions

To reduce the risk of personal injury, electric shock, fire, and damage to the power supply, please read the following specifications carefully and follow these rules to prevent danger.

- Do not install the power supply in an area with inflammable and explosive materials to avoid explosion and fire.
- Do not disassemble the power supply or replace the device without permission to avoid electric shock.

Modification Resume

Version	Modification description		Modified date	Remark
	before fixing	Before and after the change		
00	first release	---	2022/8/20	